



Main applications

- Industrial furnaces for heat treatments, metallurgy
- Fusion, sinterization, nitriding furnaces
- Furnaces for ceramics and precious metals
- Dryers
- Heating systems with monophase and triphase transformers
- Heating systems with Super Kanthal™ resistors
- Heating systems with Silicon carbide resistors

Main features

- Current levels from 40A to 250A, 480VAC, 600Vac or 690Vac
- Trigger configurable in "Zero crossing" (Fixed Cycle, Burst Firing, Half single Cycle) or "Phase angle"
- PID regulator for integrated closed-loop control (optional)
- Configurable analog input for: Volt, mA, potentiometer sensor and digital input (PWM)
- Incorporated fuse (optional)
- Total and partial load interrupt alarm (optional)
- Current limit (optional)
- Feedback V, I, P (optional)
- Configurations: Monophase, Biphas and Triphase (synchronized)
- Fieldbus (optional): Modbus RTU, Profibus DP, CanOpen, Modbus-TCP, Ethernet IP, EtherCAT
- Keypad for parameter configuration/read (optional)
- Configuration from PC
- CE, UL

PROFILE

GFW is more than a controller and more than a mono-bi-triphas solid state power unit: it integrates these functions in mechanical solutions that are modular, compact, and optimized to control any type of electric heating in a wide range of applications and markets.

The incorporated PID controller (optional) directly acquires the signal from the thermocouple or resistance thermometer and controls power by means of double SCR junctions, and provides physical Relay/Logic outputs for alarms and/or cooling functions.

Current levels range from 40A to 250A, voltage from 90 VAC to 600VAC/690VAC.

The command input is configurable and accepts 0-10V, 0/4-20mA signals, potentiometers, logic signals, including with PWM modes for cost effective solutions.

The device can also be operated via Modbus RTU serial communication, with IN/OUT chain connections facilitated by plug-in RJ10 (telephone) connectors, or with various types of Fieldbus (Optional).

GFW can also be used as an advanced actuator, in this case receiving the power signal via analog input in Volt, mA, potentiometer or Fieldbus.

In Biphas or Triphas configurations, a "Master" module handles synchronisms for correct functioning of all control modes (zero crossing or phase angle).

Extra-rapid fuses can also be installed in the GFW controllers (under the front cover) and are simple and easy to replace.

Thanks to sophisticated Hardware and Software solutions, you can precisely control resistive loads with zero crossing trigger modes (with three different variants to optimize cycle time) or special resistors such as Super Kanthal™, Silicon Carbide, and monophase and triphas transformer primaries with phase control modes.

All four trigger modes are software configurable and provide:

- **ZC**: Zero Crossing constant cycle time (settable in range 1-200sec), for conventional loads
- **BF**: Burst-Firing, Zero crossing with optimized minimum cycle time, for systems

with low thermal inertia, medium-wave IR lamps

- **HSC**: Half Single Cycle Zero Crossing corresponds to Burst Firing that manages single semi-cycles of conduction or stop cycles, useful for short-wave IR lamps, reduces flickering and limits generation of EMC noise on the power line (applied only to singlephase load or 3-phase open delta 6 leads)

- **PA**: Phase angle control, useful for short-wave IR lamps, transformer primaries. Completely eliminates flickering of load filaments.

Soft Start ramp functions can be assigned to these controls, with options such as "current limit" that keeps current peaks at power-on and RMS current level at full power under control.

GFW runs complete diagnostics of current, voltage, power, and temperature levels:

Current Diagnostics:

- Total and partial load interrupt alarm
- Self-learn function of alarm limit for interrupted load.

- Alarm for SCR in short circuit
- Alarm for load in short circuit or overcurrent
- Alarm for interrupted internal fuse

Voltage Diagnostics:

- Alarm for absence of phase
- Signal for incorrect rotation of 3 phases (for triphase applications)
- Alarm for triphase line unbalanced

Temperature Diagnostics:

- Measurement of power module temperature
- Alarm for over temperature of power module
- Measurement of power terminals temperature
- Alarm for over temperature of power terminals
- Alarm for absence of 24V supply to cooling fan.

Parameters can be configured from an optional keypad with LCD screen that attaches magnetically to the front panel and from PC with the GF_eXpress configuration kit, which lets you save all parameters in a configuration file that is easy to manage and to copy to other devices.

GFW always provides an RS485 serial connection with Modbus RTU protocol to control currents, voltages, powers, load status, and device status from the supervisor terminal (HMI) or PLC.

A second (optional) communication port is offered that lets you choose from among the following Fieldbuses:

Modbus RTU, Profibus DP, CanOpen, Devicenet, Modbus-TCP, Ethernet IP, EtherCAT.

MODELS

General features:

Nominal voltage: 480 or 600V or 690V
 Nominal current: 40, 60, 100, 150, 200, 250 Arms @ 40°C in continuous service.

Isolation HV

Rated isolation voltage input/output:
 4000Vac

INPUTS

Control analog input

Voltage: 5Vdc, 10Vdc
 Current: 0...20mA, 4...20mA
 Potentiometer: From 1KΩ to 10KΩ (auto-fed by 5V from GFW)

Digital inputs (N. 3)

Range 5-30V max 7mA
 PWM input control: 0,03...100Hz
 (Configurable Features).

PID inputs (Optional)

Configurable with
 TC input: type J, K, R, S, T, custom, PT100 RTD input
 Voltage input: 60 mV, 1V
 Current input: 0-20 mA, 4-20mA

TC AUX inputs (Optional)

N. 4 configurable input:
 type TC J, K, R, S, T
 Or 60 mVdc Linear input

Voltage line range

Range: 90V... V_nominal _product
 Frequency: 50-60Hz

Current load range:

Range: 0... 2*I_nominal_product

Key HB:

HB alarm calibration ON or reset memory alarms.

OUTPUTS

Power output, function mode:

ZC – Zero Crossing fixed cycle time
BF – Burst Firing (Zero-crossing minimum optimize cycle time)
HSC – Half Single Cycle (Zero-crossing corresponds to Burst Firing that manages single semi-cycles of conduction or stop cycles.)
PA – Phase Angle

Potentiometer power outputs:

5Vdc max 10mA

ALARM OUTPUTS

n. 2 Relay N.A. (OUT9-10)
 n. 4 Optional outputs: Relay, Triac, Direct, Digital (OUT 5-6-7-8)

Thermic Dissipation:

GFW models dissipate thermic power based on load current:
 $P_{dissipation} = I_{load_Arms} * 1.3V (W)$

Protective fuse:

GFW 40-250: installed inside product (optional)

LED

N. 8 LEDs state indicator

Modbus RS485 Serial (PORT1)

This lets you connect the GFW to a PLC or HMI via a simple RJ10 telephone wire by using an RS485 serial line with Modbus protocol.

The Baud-Rate is configurable from 1200 Baud to 19200 Baud.

A pair of rotary-switches lets you quickly assign the node address.

A dip-switch lets you internally insert the line termination resistance.

FieldBus Serial PORT2 (optional)

An optional FieldBus card (PORT2) can be inserted into the bottom of the device. The following types are available:
 Modbus RTU, Profibus DP, CanOpen, Devicenet, Modbus-TCP, Ethernet IP, EtherCAT .

GFW-OP Serial Keypad

A DB9 front panel connector lets you connect the GFW to the Gefran GFW-OP keypad (optional) for parameter configuration and device supervision.

Installation notes:

- To assure maximum reliability, it is essential to install the unit correctly in the panel in order to guarantee adequate heat exchange between the heat sink and the room under natural convection conditions.
- Install the unit vertically (max 10° inclination from vertical axis).
- Vertical distance between unit and panel wall >100mm
- For model without electronic fuse, use

the high speed fuses specified in the catalog

- Applications with solid state power units must also include an automatic safety switch to cut out the load power line.

Limits of use

- Dissipation of thermic power on the device with restraints on the ambient temperature of the installation.

- Equip the cabinet with an external air change or air-condition it, to put out dissipated power.

- Line transistor max. voltage and derivative limits, for which the solid state relay is equipped with inside safety devices (based on the models)

- Presence of load current dispersion (range 5-20mA depending on model) in absence of thyristor conduction due to internal RC protections.

DERATING CURVES

GFW 40 / 60 / 100

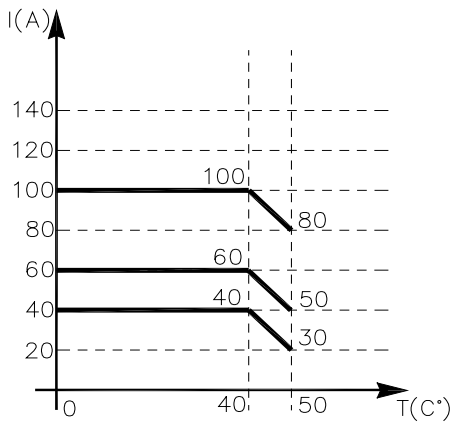

GFW 150 / 200 / 250

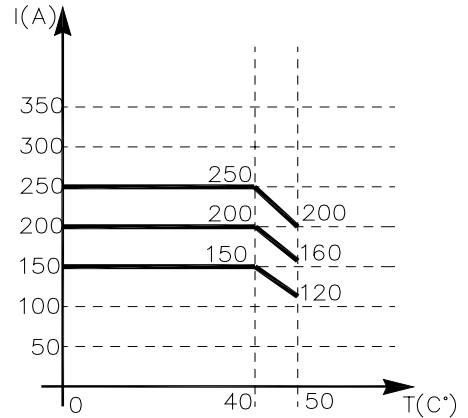

DESCRIPTION OF CONNECTIONS

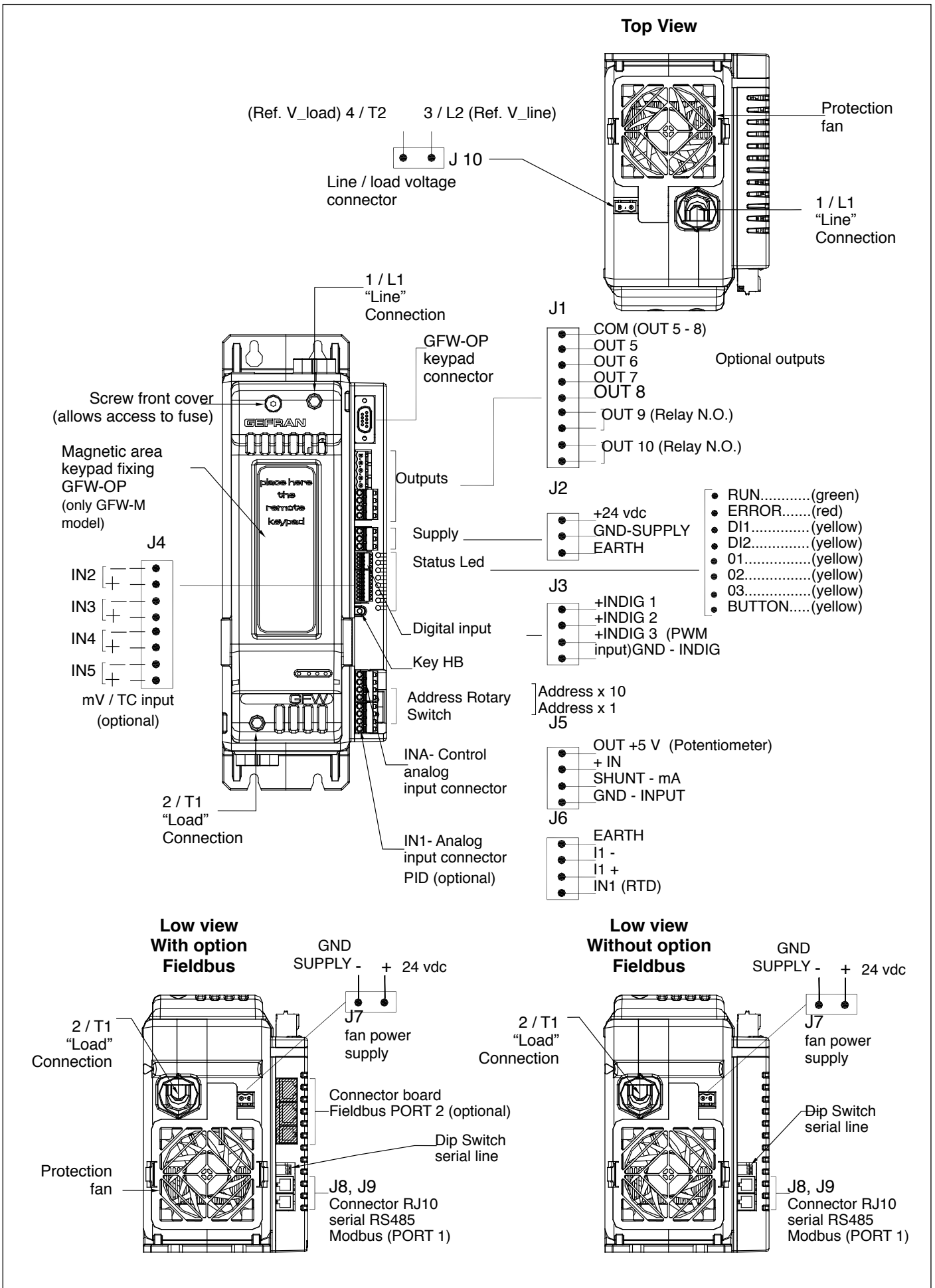

FUNCTION MODE

Trigger modes

The GFW provides the following power control modes:

- modulation via variation of phase angle: PA modality
- modulation via variation of number of conduction cycles with "zero crossing" trigger": ZC, BF, HSC modality.

PA - Phase angle

This mode manages power on the load by modulating load phase angle

ex: if power to be transferred to the load is 100%, $\theta = 180^\circ$

ex: if power to be transferred to the load is 50%, $\theta = 90^\circ$

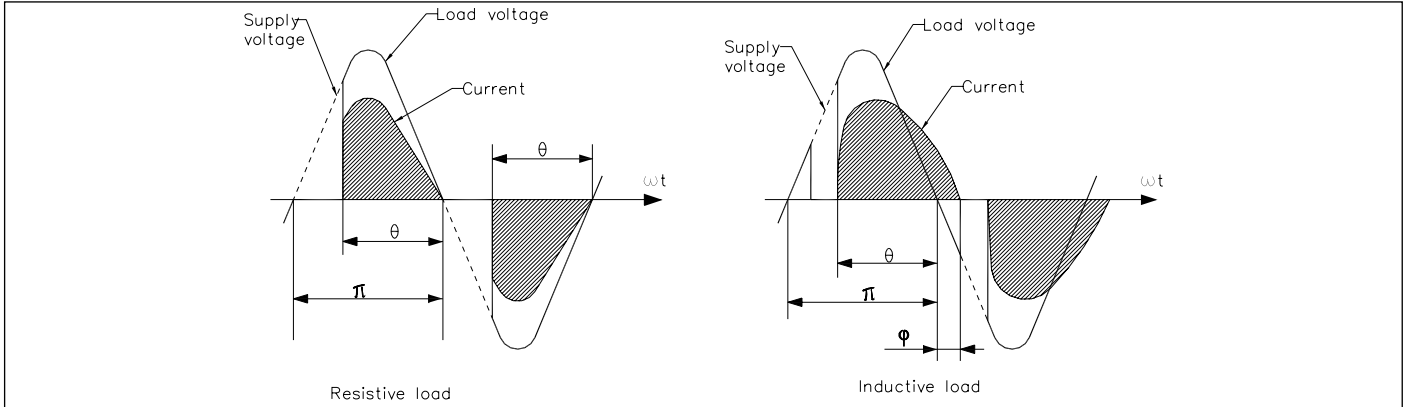

Zero Crossing mode

This function eliminates EMC noise. This mode controls power on the load via a series of conduction ON and non conduction OFF cycles.

ZC - Zero Crossing constant cycle time ($T_c \geq 1$ sec, settable from 1 to 200 sec) Cycle time is divided into a series of conduction and non conduction cycles in proportion to the power value to be transferred to the load.

For example, if $T_c = 10$ sec, if the power value is 20% there is conduction for 2 sec (100 conduction cycles @ 50Hz) and non conduction for 8 sec (400 non conduction cycles @ 50Hz).

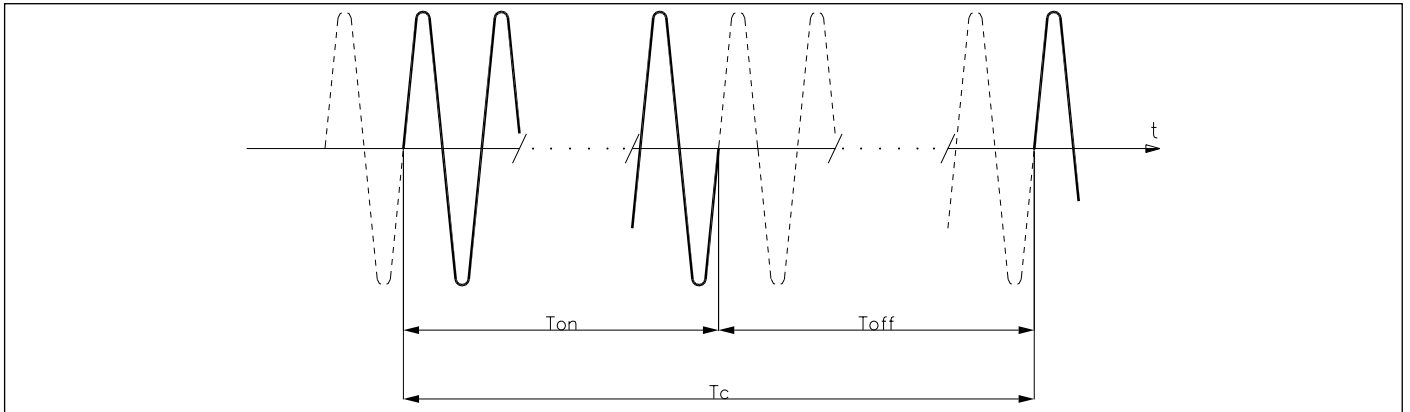

BF - Burst Firing, Zero Crossing variable cycle time.

This mode controls power on the load via a series of conduction ON and non conduction OFF cycles.

The ratio of the number of ON cycles to OFF cycles is proportional to the power value to be supplied to the load.

The CT repeat period is kept to a minimum for each power value (whereas in ZC mode the period is always fixed and not optimized)

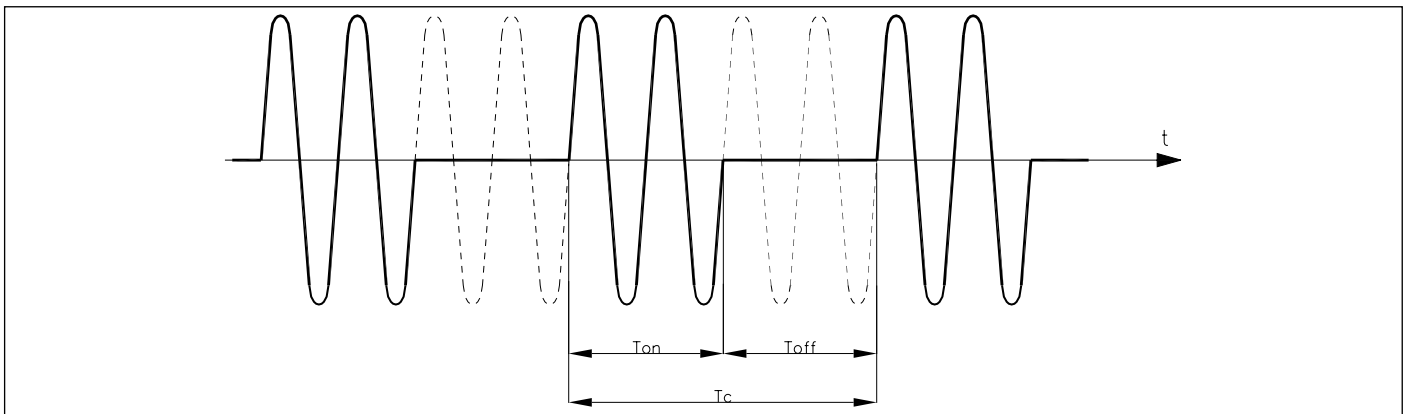

Example of operation in BF mode with power at 50%.

A parameter defines the minimum number of conduction cycles settable (from 1 to 10).

In the example, this parameter = 2.

FUNCTION MODE

HSC - Half single cycle

This mode corresponds to Burst Firing that manages Semi-cycles of on and off.

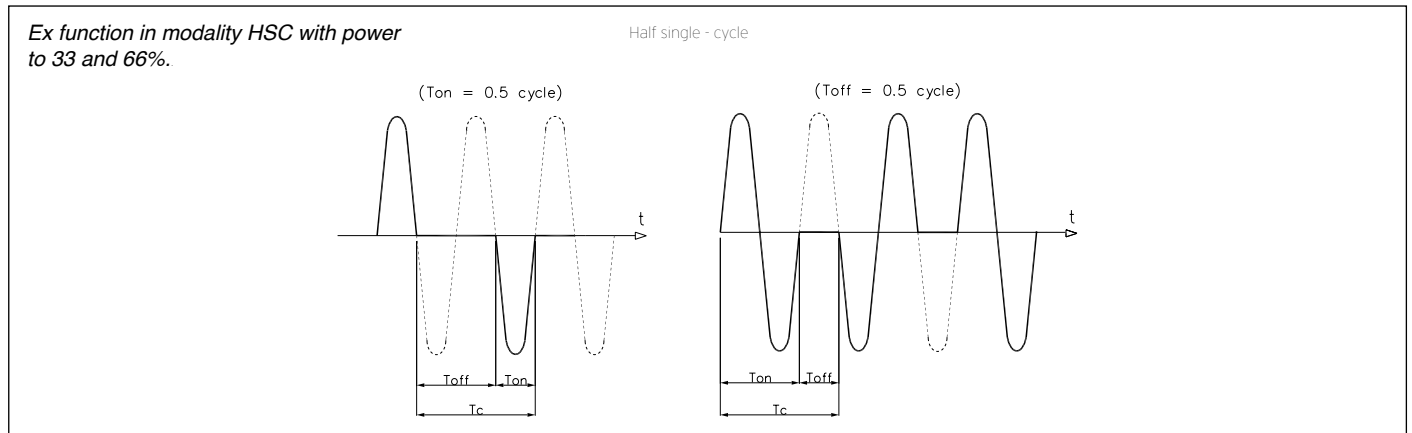

Softstart or Ramp at power-on

This type of start can be enabled in either phase control or pulse train mode.

With phase control, the increment of firing angle θ stops at the corresponding power value to be transferred to the load.

The control of maximum current spike can be enabled during the ramp phase (this is useful in case of short circuit on the load or loads with other temperature coefficients to automatically adjust the start time of the load).

The ramp is automatically re-enabled if the GFW remains off for a (settable) time.

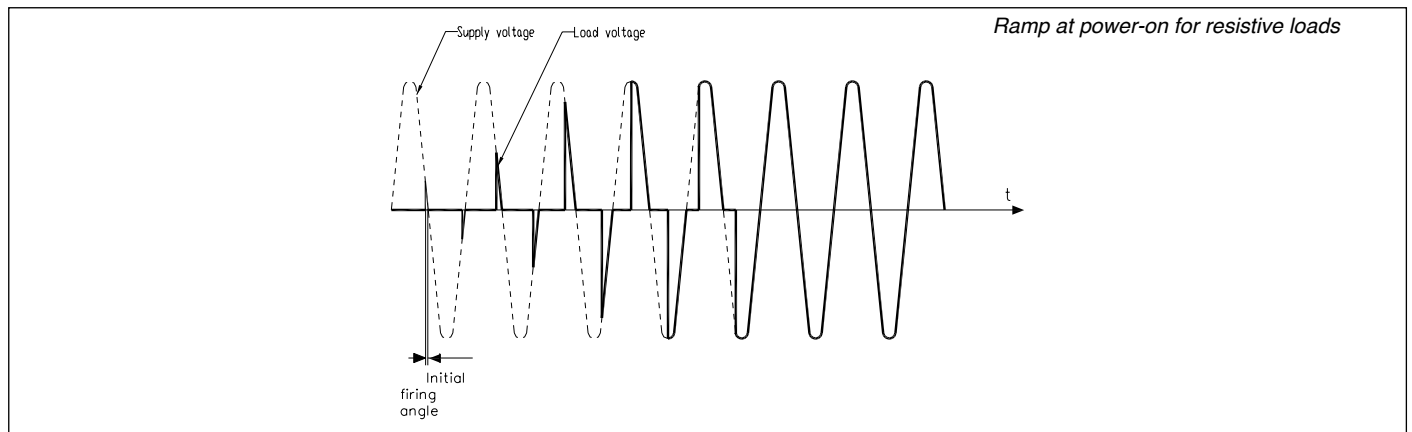

DT - "Delay triggering" of first cycle (only for control modes ZC, BF) Settable from 0° to 90° .

Useful for inductive loads (transformer primaries) to prevent current spike that could in certain cases trip the high-speed fuses that protect the SCRs.

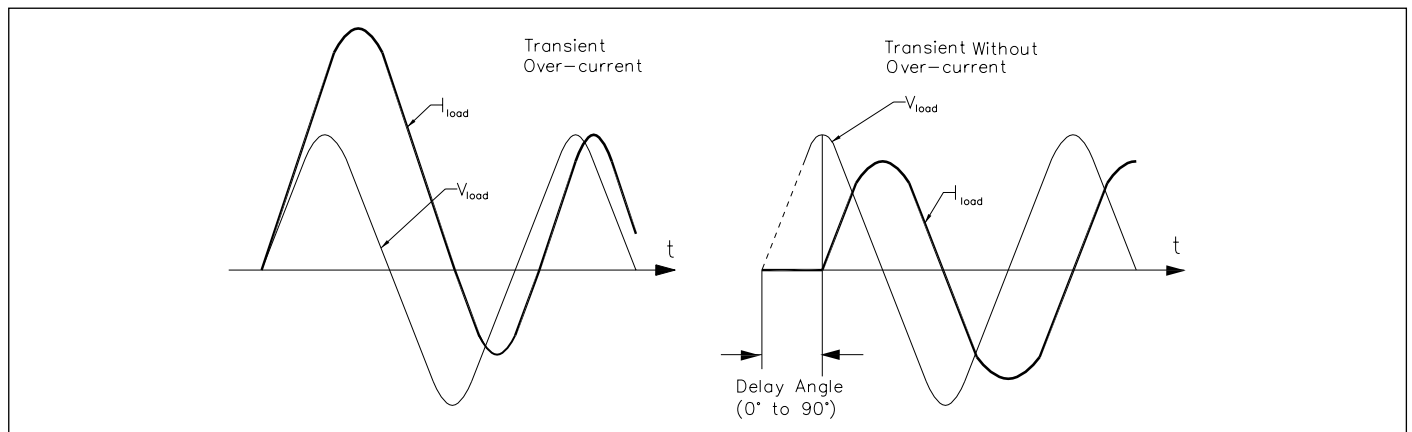

DIMENSIONS

GFW MASTER

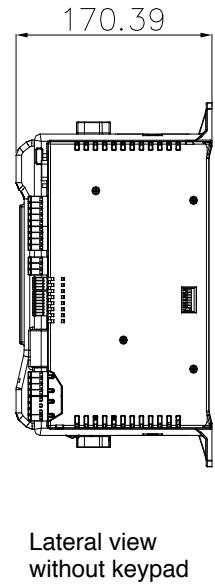
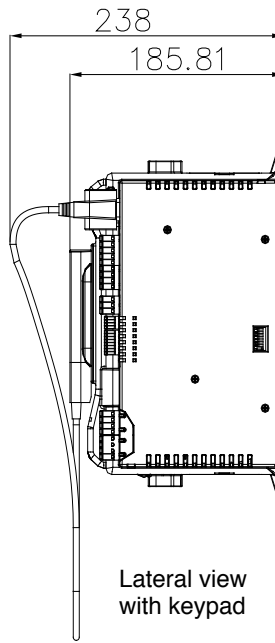
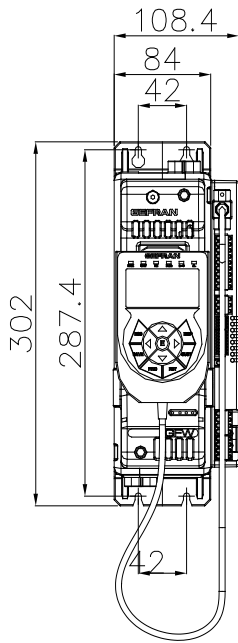

GFW DUAL-PHASE (Master + 1 Expansion)

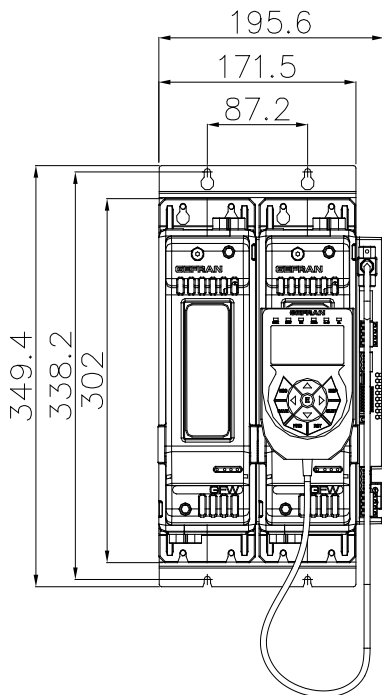

GFW THREE-PHASE (Master + 2 Expansions)

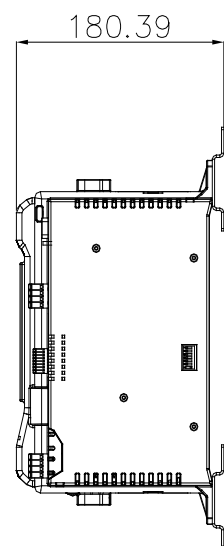
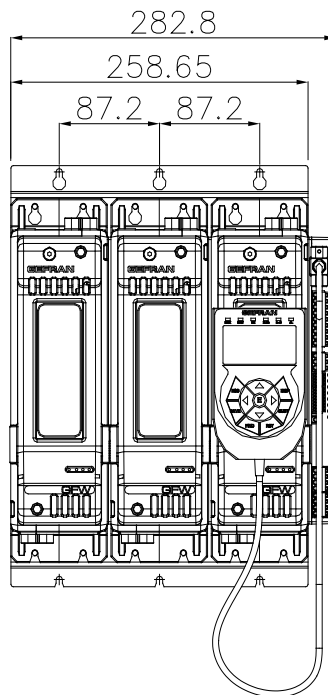

TEMPLATE DIMENSIONS

PANEL MOUNTING AND CUT-OUT DIMENSIONS

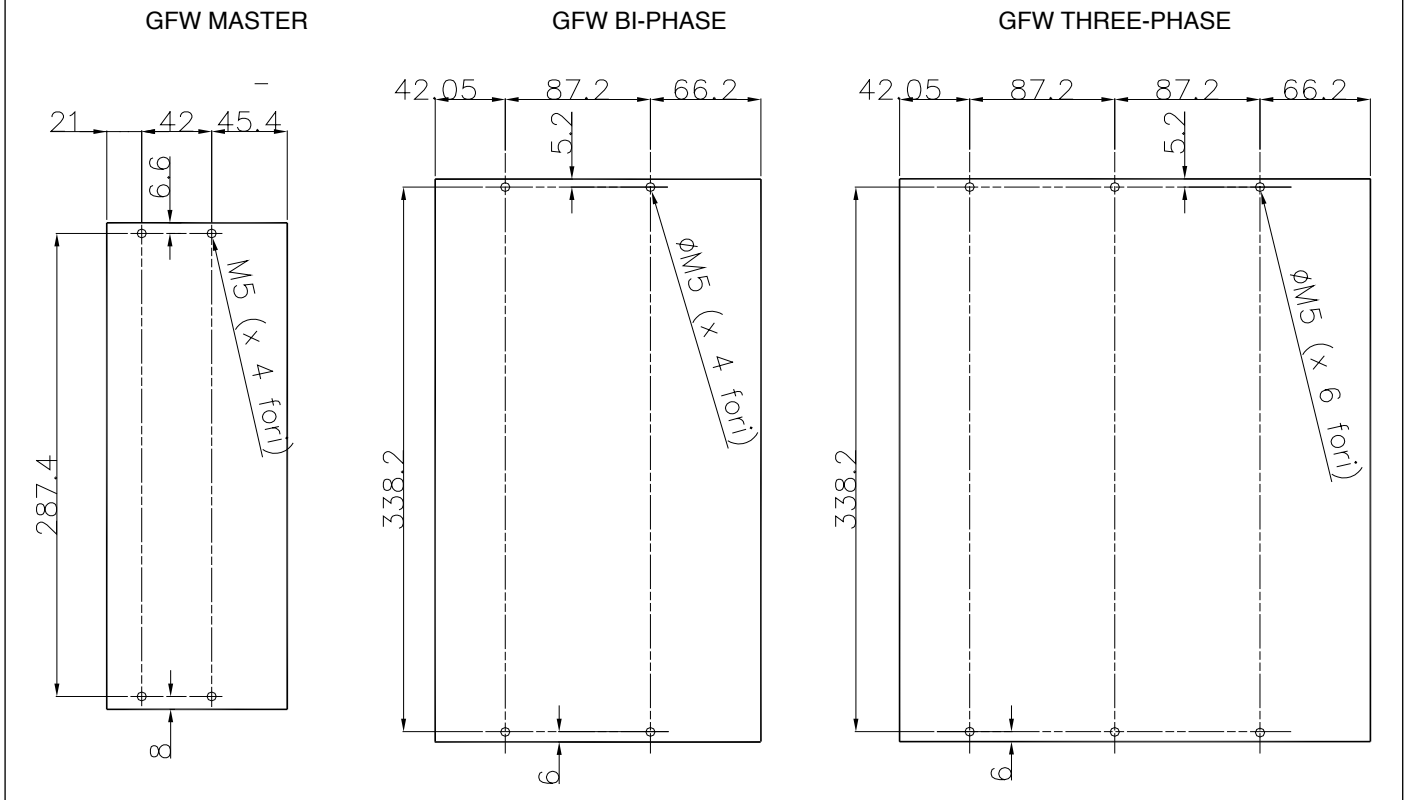

Fastening may be done with (5MA). All dimensions are expressed in mm.

TECHNICAL DATA

General features

Category of use: AC51, AC55b, AC56a

Load type:

AC51 resistive or low-inductance loads

AC55b short-wave infrared lamp (SWIR)

AC56a transformers, resistive loads with high temperature coefficient

Trigger mode:

PA - load control via adjustment of firing phase angle

ZC - Zero Crossing with constant cycle time (settable in range 1-200sec)

BF - Burst Firing with variable cycle time (GTT) optimized min.

HSC - Half Single Cycle corresponds to Burst Firing that includes ON and OFF half-cycles.

Useful for reducing flicker with short-wave IR loads (applied only to calibrate each time you change feedback mode).

Nominal voltage:

480Vac (max range 90-530Vac)

600Vac (max range 90-660Vac)

690Vac (max range 90-760Vac)

Nominal frequency: 50-60Hz

Non-repetitive voltage:

1200Vpk (models 480Vac)

1600Vpk (models 600Vac/ 690Vac)

Control analog input:

Voltage: 0...5Vdc, 0...10Vdc (impedance > 100K Ω)

Current: 0...20mA, 4...20mA (impedance 125 Ω)

Potentiometer: from 1K Ω to 10K Ω (auto-fed by 5V by GFW)

Digital inputs

Range 5-30V max 7mA

PWM input control: 0,03...100Hz (only for INDIG 3)

(Configurable Features). 1500V isolation

PID Input

Sampling time: 60msec

Accuracy: 0,2% FS \pm 1 scale points 25 $^{\circ}$ C.

Thermal drift: <100ppm/ $^{\circ}$ C scale points.

Type:

- Thermocouples ITS90: J, K, R, S, T, custom (IEC584-1, CEI EN 60584-1, 60584-2)

Internal cold junction compensation

with automatic compensation.

Selectable temperature range: $^{\circ}$ C/ $^{\circ}$ F

- Thermoresistance: Pt100 DIN 43760 Max. resistance 20 Ω

Selectable temperature range: $^{\circ}$ C/ $^{\circ}$ F

- Voltage: range 0/12...60mV, Ri > 1M Ω 0/0,2...1V, Ri > 1M Ω custom linearization at 32 sections

- Current: range 0/4...20mA, Ri = 50 Ω custom linearization at 32 sections

TC AUX input

Sampling time: 480msec

Accuracy: 1% FS \pm 1 scale point 25 $^{\circ}$ C.

Type:

- Thermocouples ITS90: J, K, R, S, T, custom (IEC584-1, CEI EN 60584-1, 60584-2)

Internal cold junction compensation with automatic compensation.

- Voltage: range 0/12...60mV, Ri > 1M Ω

Voltage line range

Range: 90... V_nominal_product

Frequency: 50-60Hz

Accuracy:

1% f.s with neutral connected,

2% f.s. without neutral connected

Voltage load range:

Accuracy: 1% f.s with load voltage measurement option (VLOAD option)

Accuracy: 2% f.s without option VLOAD

Current load range:

measures RMS value

Accuracy: 2% f.s at room temperature of 25°C. Sampling time: 0.25msec

HB alarm output (optional)

The HB function detects partial or total load interruption.

The control measures load current by means of an internal device.

The current limit value is set via an automatic procedure activated with the HB button located near the upper connector.

The alarm output is obtained by means of outputs OUT 9-10 (or OUT 5-8).

RS485 Serial (PORT1)

Double RJ10 connector

RTU RS485 Modbus Protocol

Baud-Rate configurable from 1200 Baud to 115000 Baud

Pair of rotary-switches for node address

Dip-switch for insertion of line termination resistance.

Isolation 1500V

Field bus (PORT2)

Protocol:

Modbus RTU _____ 115Kbps

CANopen/Euromap 66 ____ 10K...1Mbps

Profibus DP _____ 9,6...12Mbps

DeviceNet _____ 125K...500Kbps

Ethernet IP/Modbus TCP __ 10/100Mbps

EtherCAT _____ 10/100Mbps

OUTPUTS**Isolation HV**

Rated isolation voltage input/output: 4000Vac

GFW 40

Nominal current 40 Arms @ 40°C in continuous service

Non-repetitive overcurrent t=10ms:

1400 A

I²t for blowout: 10000 A²s

dV/dt critical: 1000 V/μs

GFW 60

Nominal current 60 Arms @ 40°C in continuous service

Non-repetitive overcurrent t=10ms: 1500 A

I²t for blowout: 12000 A²s

dV/dt critical: 1000V/μs

GFW 100

Nominal current 100 Arms @ 40°C in continuous service

Non-repetitive overcurrent t=10ms: 1900A

I²t for blowout: 18000 A²s

dV/dt critical: 1000V/μs

GFW 150

Nominal current 150Arms @ 40°C in continuous service.

Non-repetitive overcurrent t=10ms: 5000 A

I²t for blowout: 125000 A²s

dV/dt critical: 1000V/μs

GFW 200

Nominal current 200 Arms @ 40°C in continuous service.

Non-repetitive overcurrent t=10ms: 8000 A

I²t for blowout: 320000 A²s

dV/dt critical: 1000V/μs

GFW 250

Nominal current 250Arms @ 40°C in continuous service.

Non-repetitive overcurrent t=10ms: 8000 A

I²t for blowout: 320000 A²s

dV/dt critical: 1000V/μs

Thermic Dissipation:

GFW models dissipate thermic power based on load current:

Pdissipation = I_{load_Arms} * 1.3V (W)

For models with integrated fuse, also consider dissipated power at rated current shown on the fuse table.

LED

N. 8 LEDs indicator:

RUN (green) RUN state of the CPU ER-ROR (red) error

DI1 (yellow) DI1 digital input state

DI2 (yellow) DI2 digital input state

O1 (yellow) Out.1 main input state

O2 (yellow) Out.2 main input state

O3 (yellow) Out.3 main input state

BUTTON (yellow) State Key HB

Power supply

24Vdc/+/-10% max.10VA

Isolation voltage: 1000V

Cooling Fan Power Supply

24Vdc/+/-10%

Input @ 25Vdc: max 500 mA

Ambient conditions

Working temperature: 0-50°C (see the derating curve)

Storage temperature: -20°C - +85°C

Max. relative humidity: 85% UR non-condensing

Max. installation altitude: 2000m above mean sea level

Installation requirements: Installation category II, pollution level 2, double isolation

Max. temperature of air surrounding device 40°C for temperature >40°C refer at derating curves

- Device type: "UL Open Type"

Installation: panel with screws

Dimensions: see dimensions and installation

Weight

models consider with integrated fuse:

GFW -M 40/60/100 2,2 Kg

GFW -M 150/200/250 2,6 kg

GFW-E 40/60/100 2,0 kg

GFW-E 150/200/250 2,4 kg



ELECTRICAL CONNECTIONS



POWER CONNECTIONS

RECOMMENDED WIRE GAUGES

GFW CURRENT LEVEL	TERMINAL	WIRE GAUGE	TERMINAL TYPE	TIGHTENING / TOOL TORQUE
40A	1/L1, 2/T1	10 mm ² 7 AWG	Wire stripped for 25 mm or with crimped pre-insulated terminal tube CEMBRE PKC1018	4 ... 5 Nm / Flat-head screwdriver tip 1 x 5.5 mm
60A	1/L1, 2/T1	16 mm ² 5 AWG	Wire stripped for 25 mm or with crimped pre-insulated terminal tube CEMBRE PKC1618	4 ... 5 Nm / Flat-head screwdriver tip 1 x 5.5 mm
100A	1/L1, 2/T1,	35 mm ² 2 AWG	Wire stripped for 25 mm or with crimped pre-insulated terminal tube CEMBRE PKC35025	4 ... 5 Nm / Flat-head screwdriver tip 1 x 5.5 mm
150A	1/L1, 2/T1	70 mm ² 2/0 AWG	Wire stripped for 25 mm or with crimped pre-insulated terminal tube CEMBRE PKC70022	5 ... 6 Nm / No. 6 hex head wrench
200A	1/L1, 2/T1	95 mm ² 4/0 AWG	Wire stripped for 25 mm or with crimped pre-insulated terminal tube CEMBRE PKC95025	5 ... 6 Nm / No. 6 hex head wrench
250A	1/L1, 2/T1	120 mm ² 250 AWG	Wire stripped for 25 mm	5 ... 6 Nm / No. 6 hex head wrench
---	3/L2 (Ref. Vline) 4/T2 (Ref. Vload)	0.25 ... 2.5 mm ² 23...14 AWG	Wire stripped for 8 mm or with tag terminal	0.5 ... 0.6 Nm / Flat-head screwdriver tip 0.6 x 3.5 mm

SIGNAL CABLES:

J1: Output J2, J7: Power supply 24V J5, J6: Control inputs		0,2 - 2,5mm ²	24 - 14AWG
		0,25 - 2,5mm ²	23 - 14AWG

J3: Digital input J4: Input mV / TC AUX		0,14 - 0,5mm ²	28 - 20AWG
		0,25 - 0,5mm ²	23 - 20AWG

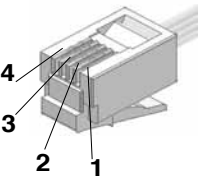
J8, J9: RS 485	Connector RJ10 4-4 pin	Nr. Pin	Name	Description	Note
			1	GND1 (**)	
		2	Tx/Rx+	Data reception/transmission (A+)	
		3	Tx/Rx-	Data reception/transmission (B-)	
		4	+V (reserved)		

Cable type: flat telephone cable for pin 4-4 conductor 28AWG

ORDER CODE

GFW -
Mono-phase



Model	
Master with CPU	M

Nominal Current	
40Ampere	40
60Ampere	60
100Ampere	100
150Ampere	150
200Ampere	200
250Ampere	250

Nominal Voltage	
480Vac	480
600Vac	600
690Vac	690

PID Opt. Temperature	
Absent	0
TC/RTD/Linear input + PID	1

Auxiliaries Inputs	
Absent	0
4 TC/linear input (60mV)	1

Control options	
Absent	0
Current limit	1
Current limit and feedback V,I,P	2
Current limit and feedback V,I,P + Vload input	3

FIELDBUS Port 2 opz.	
0	Absent
M	Modbus RTU
P	Profibus DP
C	CANopen
E	Ethernet Modbus TCP
E1	Ethernet IP
E2	EtherCAT

Fuses	
0	Absent
1	Self-contained

Diagnostic / Alarm option	
0	Absent
1	Partial or total load failure alarm. (HB)

Auxiliary Output opz.	
0	Absent
R	4 Relays
D	4 Digital outputs
C	4 Direct analogue outputs
T	4 Triac outputs

GFW -
Mono-phase

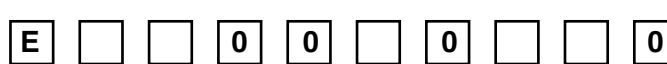

Model	
Expansion module for Dual-Phase and Three-Phase	E

Nominal Current	
40Ampere	40
60Ampere	60
100Ampere	100
150Ampere	150
200Ampere	200
250Ampere	250

Nominal Voltage	
480Vac	480
600Vac	600
690Vac	690

Fuses	
0	Absent
1	Self-contained

Diagnostic / Alarm option	
0	Absent
1	Partial or total load failure alarm. (HB)

Control options	
0	Absent
1	Current limit
2	Current limit and feedback V,I,P
3	Current limit and feedback V,I,P + Vload input

GEFRAN spa reserves the right to make aesthetic or functional changes at any time and without notice

ORDER CODE

GFW -
Dual-Phase



Model	
1 module master (CPU) + 1 expansion module	2PH

Nominal Current	
40Ampere	40
60Ampere	60
100Ampere	100
150Ampere	150
200Ampere	200
250Ampere	250

Nominal Voltage	
480Vac	480
600Vac	600
690Vac	690

PID Opt. Temperature	
Absent	0
TC/RTD/Linear input + PID	1

Auxiliaries Inputs	
Absent	0
4 TC/linear input (60mV)	1

Control options	
Absent	0
Current limit	1
Current limit and feedback V,I,P	2
Current limit and feedback V,I,P + Vload input	3

FIELDBUS Port 2 opz.	
0	Absent
M	Modbus RTU
P	Profibus DP
C	CANopen
E	Ethernet Modbus TCP
E1	Ethernet IP
E2	EtherCAT

Fuses	
0	Absent
1	Self-contained

Diagnostic / Alarm option	
0	Absent
1	Partial or total load failure alarm. (HB)

Auxiliary Output opz.	
0	Absent
R	4 Relays
D	4 Digital outputs
C	4 Direct analogue outputs
T	4 Triac outputs

ORDER CODE

GFW -
Three-phase



Model	
1 module master (CPU) + 2 expansion modules	3PH

Nominal Current	
40Ampere	40
60Ampere	60
100Ampere	100
150Ampere	150
200Ampere	200
250Ampere	250

Nominal Voltage	
480Vac	480
600Vac	600
690Vac	690

PID Opt. Temperature	
Absent	0
TC/RTD/Linear input + PID	1

Auxiliaries Inputs	
Absent	0
4 TC/linear input (60mV)	1

Control options	
Absent	0
Current limit	1
Current limit and feedback V,I,P	2
Current limit and feedback V,I,P + Vload input	3

FIELDBUS Port 2 opz.	
0	Absent
M	Modbus RTU
P	Profibus DP
C	CANopen
E	Ethernet Modbus TCP
E1	Ethernet IP
E2	EtherCAT

Fuses	
0	Absent
1	Self-contained

Diagnostic / Alarm option	
0	Absent
1	Partial or total load failure alarm. (HB)

Auxiliary Output opz.	
0	Absent
R	4 Relays
D	4 Digital outputs
C	4 Direct analogue outputs
T	4 Triac outputs

ACCESSORIES

CONFIGURATION KIT

KIT PC USB / RS485 o TTL



Configuration/supervision kit for GFW by means of PC with USB (Windows environment).

Lets you read or write all of the parameters of a single GFW

A single software for all models

- Easy and rapid configuration
- Saving and management of parameter recipes
- On-line trend and saving of historical data

Component Kit:

- Connection cable PC USB <----> GFW RS485 port
- Serial line converter
- CD SW GF Express installation

ORDERING CODE

GF_eXK-2-0-0.....Cod. F049095



The human/machine interface (HMI) is simple, intuitive, and very practical thanks to the optional GFW – OP programming keyboard.

Lets you read or write all of the parameters of a single GFW-M module.

Connected with 9-pin D-SUB connector and housed in the front panel of the GFW-M by means of a magnetic plate.

- Alphameric display: 5 lines x 21 characters.
- Keys to display variable and set parameters.
- Magnetic housing

ORDERING CODE

GFW - OP.....Cod. F051664

FUSES

Model	EXTRARAPID FUSES			
	Size I ² t	Code Format	Model Code	Power Dissipated @ In
GFW 40	80A 2500A ² s	FUS-080S	DN000UB69V80 338933	5 W
GFW 60	125A 8900A ² s	FUS-125S	DN000UB69V125 338934	6 W
GFW 100	160A 16000A ² s	FUS-160S	DN000UB69V160 338935	12 W
GFW 150	200A 31500A ² s	FUS-200S	DN000UB69V200 338930	19 W
GFW 200/250 480/600V	450A 196000A ² s	FUS-450S	DN000UB60V450L 338932	17 W
GFW 200/250 690V	400A 150000A ² s	FUS-400S	DN000UB69V400L 338936	20 W

• WARNINGS



WARNING: this symbol indicates danger.

Before installation, please read the following advices:

- follow the indications of the manual scrupulously when making the connections to the instrument.
- use a cable that is suitable for the ratings of voltage and current indicated in the technical specifications.
- if the instrument is used in applications where there is risk of injury to persons and damage to machines or materials, it is essential that it is used with an auxiliary alarm device.

It is advisable to verify frequently that the alarm device is functional even during the normal operation of the equipment.

- The instrument must NOT be used in environments where there could be the presence of dangerous atmospheres (inflammable or explosive).
- During continuous operation, the heatsink may reach 100°C and remain at a high temperature due to thermal inertia even after the device is switched off. Therefore, DO NOT touch the heat sink or the electrical wires.
- do not operate on the power circuit unless the main supply is disconnected.
- DO NOT open the cover if device is "ON"!

(use the holes in the cover for eventual re-calibration).

Installation:



- connect the device to the ground using the proper ground terminal.
- the power supply wiring must be kept separate from that of inputs and outputs of the instrument; always check that the supply voltage corresponds to that indicated on the instrument cover.
- Delete this line entirely..
- keep away from dust, humidity, corrosive gases and heat sources.
- The connection cable must be shorter than 3 meters if the current transformer is used.

Maintenance: Check the correct operation of the cooling fans at regular intervals; clean the ventilation air filters of the installation at regular intervals.

- Repairs must be performed only by specialized or appropriately trained personnel. Cut off power to the device before accessing internal parts.
- Do not clean the box with solvents derived from hydrocarbons (trichloroethylene, gasoline, etc.). Using such solvents will compromise the mechanical reliability of the device. To clean external plastic parts, use a clean cloth wet with ethyl alcohol or water.

Technical service: GEFTRAN has a technical service department. Defects caused by use not conforming to the instructions are excluded from the warranty.

GEFRAN spa reserves the right to make any kind of design or functional modification at any moment without prior notice

	<p>only for 480-600V models conforme C/UL/US file no. E243386 vol. 1 sez. 5</p>
	<p>This device conforms to European Union Directive 2004/108/CE e 2006/95/CE with reference to generic standards: EN 60947-4-3 (product) EN 61010-1 (safety)</p>